

# ***Stereo Cassette Deck***

---

Operating Instructions

***TC-TX333***

## WARNING

To prevent fire or shock hazard, do not expose the unit to rain or moisture.

To avoid electrical shock, do not open the cabinet. Refer servicing to qualified personnel only.

Do not install the appliance in a confined space, such as a bookcase or built-in cabinet.

### NOTICE FOR THE CUSTOMERS IN CANADA

#### CAUTION:

TO PREVENT ELECTRIC SHOCK, DO NOT USE THIS POLARIZED AC PLUG WITH AN EXTENSION CORD, RECEPTACLE OR OTHER OUTLET UNLESS THE BLADES CAN BE FULLY INSERTED TO PREVENT BLADE EXPOSURE.

The Class B digital apparatus meets all requirements of the Canadian Interference-Causing Equipment regulations.

#### **This system is equipped with the Dolby\* B-type noise reduction system.**

\* Dolby noise reduction manufactured under license from Dolby Laboratories Licensing Corporation.

"DOLBY" and the double-D symbol  are trademarks of Dolby Laboratories Licensing Corporation.



# The TC-TX333 tape deck is designed only for the DHC-MD333 component system

Here are some of the features you can use with this tape deck when connected with the DHC-MD333 Mini Hi-Fi component system (see page 4).

## Auto Power On/Off

The tape deck power is tied with the DHC-MD333 component system (see page 6).

## CD Synchro Recording

You can easily record a CD onto a tape (see page 8).

## One Touch Play

Pressing  $\triangleright$  or  $\triangleleft$  on the tape deck when the tape deck is off automatically turns on the tape deck and the DHC-MD333, and starts playing a tape if a cassette is inserted (see page 7).

## Automatic Source Selection

You can switch from another source to the tape deck and start playing a tape just by pressing  $\triangleright$  or  $\triangleleft$  on the tape deck (see page 7).

## Timer

You can wake up to music or record a radio programme at a preset time. For details, refer to “Waking up to music” and “Timer recording radio programmes” in the DHC-MD333 component system Instruction Manual.

## Remote Control

You can operate the tape deck using the remote supplied with the DHC-MD333.

---

# Table of Contents

---

## Getting Started

---

Hooking up the system .....	4
-----------------------------	---

---

## Operations

Playing a tape .....	6
Recording a CD .....	8
Recording manually .....	9

---

## Additional Information

Precautions .....	10
Troubleshooting .....	11
Specifications .....	Back cover

# Hooking up the system

Complete steps **1** through **4** to hook up your system using the supplied cords.

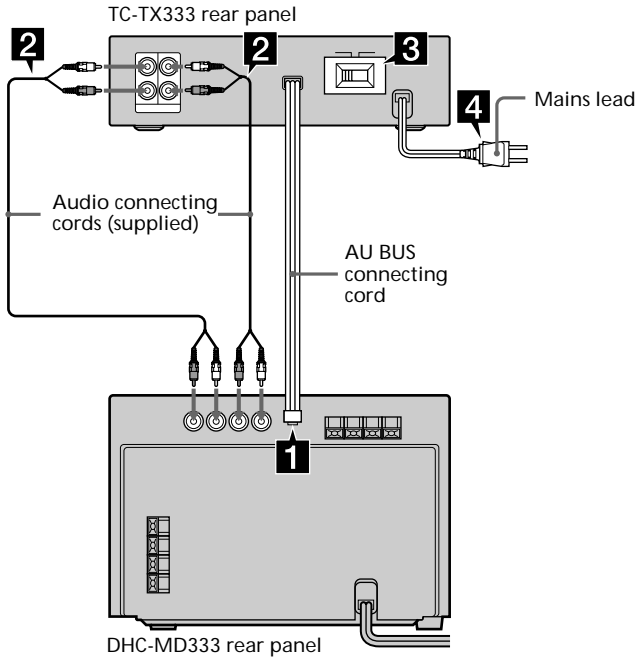

- 1** Firmly connect the AU BUS connecting cord to the AU BUS jack on the DHC-MD333.

## Note

The AU BUS connecting cord is used for exchanging signals between the tape deck and the DHC-MD333. If you do not connect the cord firmly, the tape deck and DHC-MD333 may not operate correctly.

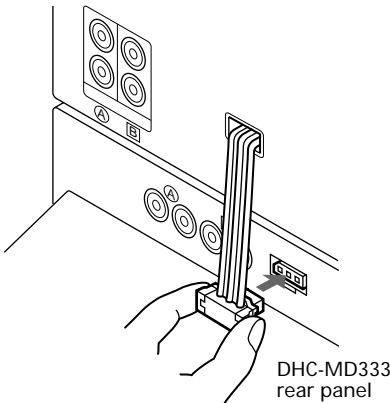

**2** Connect **(A)** to **(A)**, and **(B)** to **(B)** using the audio connecting cords. Insert the plugs into jacks of the same colour.

The two audio connecting cords are the same, so you can connect **(A)** or **(B)** using either cord.

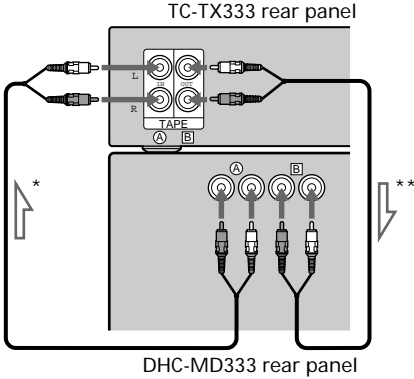

: sound flow

\* **(A)** **(A)**

The sound signals of the CD, MD and TUNER flow through the DHC-MD333 to the tape deck when you record to tape.

\*\* **(B)** **(B)**

The sound signal of the tape deck flows to the DHC-MD333 when you play a tape.

## How to insert the plugs

Insert the plugs firmly into the jacks.

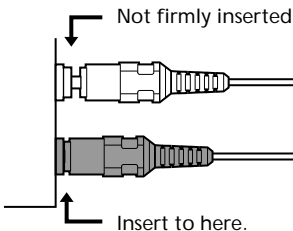

**3** Set VOLTAGE SELECTOR to the position of your local power line voltage (Except for North American and European countries model).

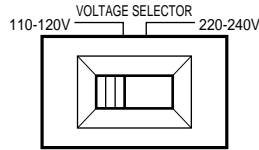

**4** Connect the Mains lead to a mains after you complete all the connections.

If the plug on this tape deck does not fit your mains, detach the supplied adapter from the plug (Except for North American and European countries).

## If there is no sound or the tape does not record at first operation

Make sure the plugs are inserted into the jacks firmly.

- If the plugs are not inserted into the **(A)** jacks firmly, you may not be able to record the sound of the CD, MD and TUNER onto a tape.
- If the plugs are not inserted into the **(B)** jacks firmly, you may not be able to listen to the sound of the tape deck.

The plugs of the audio connecting cords may be tight. Insert the plugs at the point shown in "How to insert the plugs" in step **2**.

# Playing a tape

You can use any type of tape, TYPE I (normal), TYPE II (CrO<sub>2</sub>) or TYPE IV (metal), since the tape deck automatically detects the tape type (ATS<sup>1)</sup>).

<sup>1)</sup> ATS: Automatic Tape Selection.

Tape deck  
TC-TX333

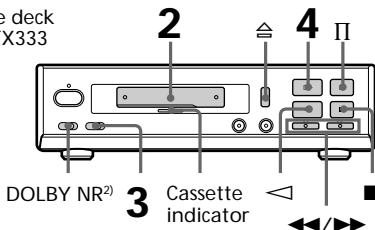

The remote  
supplied with  
the DHC-MD333

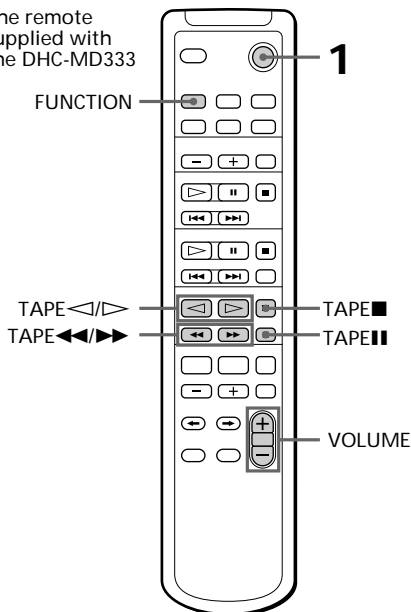

<sup>2)</sup> This tape deck is equipped with the Dolby B-type noise reduction system.

- 1 Press  $I / \odot$  on the DHC-MD333 to turn on the DHC-MD333 component system.  
The tape deck turns on automatically.

- 2 Insert a recorded tape.

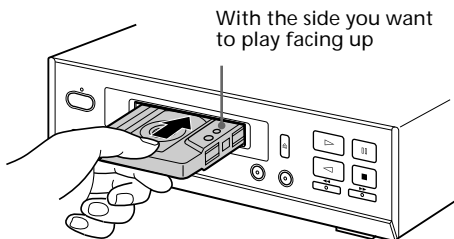

- 3 Set DIRECTION to  $\rightleftarrows$  to play one side. Set it to  $\rightleftarrows$ <sup>3)</sup> to play both sides.

- 4 Press  $\blacktriangleleft$ .  
Press  $\blacktriangleleft$  to play the bottom side. FUNCTION switches to "TAPE" automatically, then the tape starts playing.

<sup>3)</sup> The tape deck stops automatically after repeating the sequence five times.

## To play a tape using the DHC-MD333 component system

Do the following operation in step 4;

- 1 Press FUNCTION until "TAPE" appears in the display.
- 2 Press TAPE  $\blacktriangleleft$  on the remote.  
To play the bottom side, press TAPE  $\blacktriangleleft$  on the remote.

## Other operations

To	Press
Stop playing	■ (or TAPE■*).
Pause	⏸ (or TAPE⏸*).
	Press again to resume playing.
Fast-forward	■, then ►► (or TAPE►►*) for the top side. ■, then ◀◀ (or TAPE◀◀*) for the bottom side.
Rewind	■, then ◀◀ (or TAPE◀◀*) for the top side. ■, then ►► (or TAPE►►*) for the bottom side.
Find the succeeding track (AMS**)	►► (or TAPE►►*) for the top side. ◀◀ (or TAPE◀◀*) for the bottom side.
Find the preceding track (AMS**)	◀◀ (or TAPE◀◀*) for the top side. ►► (or TAPE►►*) for the bottom side.
Remove the cassette	⏏ on the tape deck.
Adjust the volume	VOLUME +/- on the remote (or turn VOLUME on the DHC-MD333).

\* Use the remote supplied with the DHC-MD333.

\*\*The Automatic Music Sensor (AMS) feature detects a blank space of more than four seconds between tracks to locate tracks quickly.

## Tips

- When you press | / ⏻ on the tape deck, only the tape deck turns on. Press | / ⏻ on the DHC-MD333 to turn on the DHC-MD333 component system.
- The cassette indicator lights up in red when a cassette is inserted and goes off when no cassette is inserted.
- Pressing ▷ or ◁ when the tape deck is off automatically turns on the tape deck and starts playing a tape if there is a cassette inserted (**One Touch Play**).
- Inserting the tape when the power is off automatically turns on the tape deck only. Press | / ⏻ on the DHC-MD333 to turn on the DHC-MD333 component system.
- You can switch from another source to the tape deck just by pressing ▷ or ◁ (**Automatic Source Selection**).
- To start playing automatically from the beginning of the tape after fast winding (**Auto Play**), press ▷ while holding down ◀◀ (for the top side) or press ◁ while holding down ►► (for the bottom side).
- When you want to reduce the hiss noise in low-level high-frequency signals, set DOLBY NR to ON.
- Using the timer function on the DHC-MD333, you can wake up to music at a preset time. For details, refer to "Wake up to music" in the DHC-MD333 component system Instruction Manual. When you set the Wake-up timer, DOLBY NR must be set on the tape deck.

## Note

The AMS feature may not work in the following cases:

- the blank space between tracks is four seconds or less.
- the sound source recorded on the right channel is different from that on the left channel as with a KARAOKE tape.
- low volume or low sound continues for a long time.
- the TV is too close to the tape deck.

# Recording a CD

## — CD Synchro Recording

The CD SYNC button lets you record from a CD to a tape easily. You can use TYPE I (normal) or TYPE II (CrO<sub>2</sub>) tape, since the tape deck automatically detects the tape type.

Tape deck  
TC-TX333

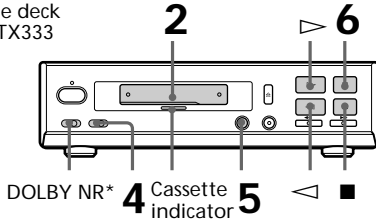

The remote  
supplied with  
the DHC-MD333

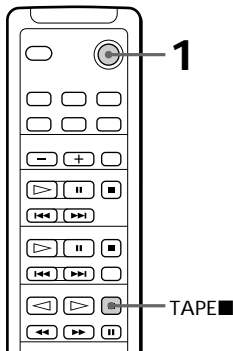

\* This tape deck is equipped with the Dolby B-type noise reduction system.

- 1 Press  $\text{I} / \text{O}$  on the DHC-MD333 to turn on the DHC-MD333 component system.  
The tape deck turns on automatically.

- 2 Insert a blank tape.

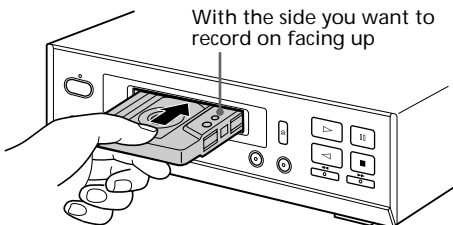

- 3 Place a CD on the disc tray of the DHC-MD333.
- 4 Set DIRECTION to  $\rightleftarrows$  to record on one side. Set it to  $\curvearrowright$  to record on both sides.
- 5 Press CD SYNC on the tape deck.  
The tape deck stands by for recording and the CD player stands by for playback. The indicators on the CD SYNC, ●REC,  $\blacktriangleright$  (for the top side) and  $\blacktriangleleft$  buttons light up.  
If you want to record starting from the bottom side, press  $\blacktriangleleft$  (for the bottom side) so the indicator on the  $\blacktriangleleft$  button lights up.
- 6 Press  $\text{II}$  on the tape deck.  
Recording starts.

### To stop recording

Press  $\blacksquare$  on the tape deck or TAPE  $\blacksquare$  on the remote.

### Tips

- When you press  $\text{I} / \text{O}$  on the tape deck, only the tape deck turns on. Press  $\text{I} / \text{O}$  on the DHC-MD333 to turn on the DHC-MD333 component system.
- Inserting the tape when the power is off automatically turns on the tape deck only. Press  $\text{I} / \text{O}$  on the DHC-MD333 to turn on the DHC-MD333 component system before recording.
- The cassette indicator lights up in red when a cassette is inserted and goes off when no cassette is inserted.
- When you want to reduce the hiss noise in low-level high-frequency signals, set DOLBY NR to ON before step 5.
- If the tape reaches the end of the top side during both sides recording, the fadeout feature prevents the track from ending abruptly at the end of the tape (Fade Synchro). The track is recorded again from the beginning of the bottom side.
- The fadeout feature also works when you record on one side only.

### Notes

- You cannot listen to other sources while recording.
- When you record on both sides, be sure to start from the top side. If you start from the bottom side, recording stops at the end of the bottom side.



# Recording manually

With manual recording, you can record just the songs you like from a CD, or start recording from the middle of the tape. You can also record a radio programme or MD.

Tape deck  
TC-TX333

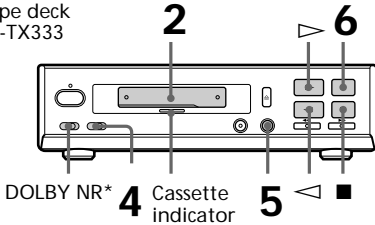

The remote  
supplied with  
the DHC-MD333

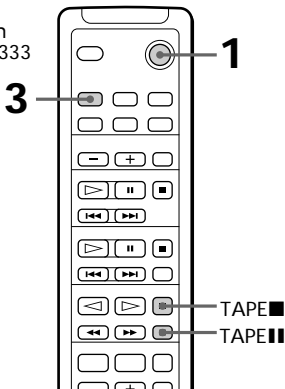

\* This tape deck is equipped with the Dolby B-type noise reduction system.

**1** Press  $\text{I/O}$  on the DHC-MD333 to turn on the DHC-MD333 component system.  
The tape deck turns on automatically.

**2** Insert a blank tape.

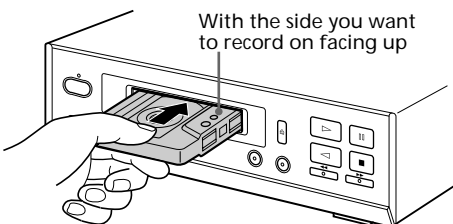

**3** Press **FUNCTION** on the DHC-MD333 until "CD," "MD" or "TUNER" appears.

**4** Set **DIRECTION** to  $\rightleftarrows$  to record on one side. Set it to  $\rightleftarrows$  to record on both sides.

**5** Press **REC** on the tape deck.  
The tape deck stands by for recording. The indicators on the **REC**,  $\triangleright$  (for the top side) and  $\triangleleft$  buttons light up.  
If you want to record starting from the bottom side, press  $\triangleleft$  (for the bottom side) so the indicator on the  $\triangleleft$  button lights up.

**6** Press  $\square$  on the tape deck.  
Recording starts.  
You can also start recording by pressing the  $\triangleright$  or  $\triangleleft$  button that is lit.

**7** Start playing on the source component.

To	Press
Stop recording	$\blacksquare$ (or <b>TAPE</b> $\blacksquare$ on the remote)
Pause recording	$\square$ (or <b>TAPE</b> $\square$ on the remote)

## Tips

- The cassette indicator lights up in red when a cassette is inserted and goes off when no cassette is inserted.
- When you want to reduce the hiss noise in low-level high-frequency signals, set DOLBY NR to ON before step 5.
- Using the timer function on the DHC-MD333, you can record radio programmes at a preset time. For details, refer to "Timer recording radio programmes" in the DHC-MD333 component system Instruction Manual. When you set the timer recording, DOLBY NR and DIRECTION mode must be set on the tape deck.

# Precautions

## On operating voltage (Except for North American and European countries model)

Before operating the tape deck, check that the operating voltage of your tape deck is identical with the voltage of your local power supply.

## On safety

- The unit is not disconnected from the AC power source (mains) as long as it is connected to the wall outlet (mains), even if the unit itself has been turned off.
- Unplug the tape deck from the wall outlet (mains) if it is not to be used for an extended period of time. To disconnect the cord (mains lead), pull it out by the plug. Never pull the cord itself.
- Should any solid object or liquid fall into the component, unplug the tape deck and have it checked by qualified personnel before operating it any further.
- The AC power cord (mains lead) must be changed only at a qualified service shop.

## On placement

- Place the tape deck in a location with adequate ventilation to prevent heat build-up in the tape deck.
- Do not place the unit in an inclined position.
- Do not place the unit in locations where it is:
  - Extremely hot or cold
  - Dusty or dirty
  - Very humid
  - Subject to vibration
  - Subject to direct sunlight

## Before placing a cassette in the tape deck

Take up any slack in the tape. Otherwise, the tape may get entangled in the parts of the tape deck and become damaged.

## When using a tape longer than 90 minutes

The tape is very elastic. Do not change the tape operations such as play, stop, and fast-winding frequently. The tape may get entangled in the tape deck.

## To save a tape permanently

To prevent a tape from being accidentally recorded over, break off the cassette tab from side A or B as illustrated.

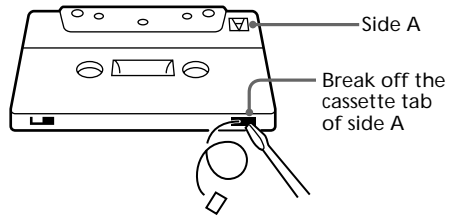
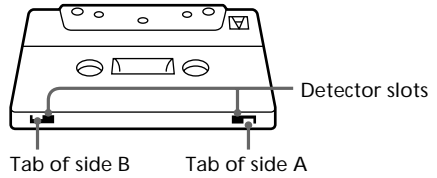

If you later want to reuse the tape for recording, cover the broken tab with adhesive tape. However, be careful not to cover the detector slots which allow the tape player to automatically detect the type of tape.

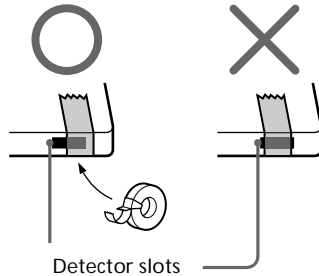

## Cleaning the tape heads

Clean the tape heads after every 10 hours of use.

When the tape heads become dirty

- the sound is distorted
- there is a decrease in sound level
- the sound drops out
- the tape does not erase completely
- the tape does not record.

Be sure to clean the tape heads before you start an important recording or after playing an old tape.

Use a separately sold dry-type or wet-type cleaning cassette. For details, refer to the instructions of the cleaning cassette.

## Demagnetising the tape heads

Demagnetise the tape heads and the metal parts that has contact with the tape after every 20 to 30 hours of use with a separately sold demagnetising cassette. For details, refer to the instructions of the demagnetising cassette.

## Cleaning the cabinet

Use a soft cloth slightly moistened with mild detergent solution.

Never use strong solvents, such as thinner or benzene, since they may damage the finish.

If you have any questions or problems concerning your tape deck, please consult your nearest Sony dealer.

---

# Troubleshooting

If you run into any problem using this tape deck, use the following checklist.

First, check that the mains lead is connected firmly and the speakers are connected correctly and firmly.

Should any problem persist, consult your nearest Sony dealer.

---

**The operation buttons on the tape deck do not work.**

- Press any of the operation buttons after  $\square\square$  stops flashing. (The buttons on the tape deck do not work for about two seconds after the tape deck turns on.)
- No cassette is inserted. Insert a cassette.

---

**The tape does not play or record.**

- There is slack in the tape. Take up any slack in the tape.
- The heads are dirty. Clean them.
- Make sure the audio connecting cords are connected correctly (see page 5).

---

**The tape does not record.**

- No cassette is inserted.
- The tab has been removed from the cassette. Cover the broken tab with adhesive tape (see page 10).
- The tape has wound to the end.

---

**The tape does not record or play, or there is a decrease in sound level.**

- The heads are dirty. Clean them.
- The record/playback heads are magnetised. Demagnetise them.

---

**The tape does not erase completely.**

- The record/playback heads are magnetised. Demagnetise them.

---

**There is excessive wow or flutter, or the sound drops out.**

- The capstans in the tape deck are dirty. Clean them using a cleaning cassette.

continued

## Troubleshooting (continued)

---

Noise increases or the high frequencies are erased.

- The record/playback heads are magnetised. Demagnetise them (see page 11).
- Move the tape deck away from the TV or VCR.

---

The sound is distorted.

- Set DOLBY NR to the same setting in which the tape was recorded.
- Move the tape deck away from the TV or VCR.

---

There is no sound.

- The mains lead is disconnected from the mains.
- Make sure the audio connecting cords are connected correctly (see page 5).

---

The remote supplied with the DHC-MD333 does not function.

- Press FUNCTION on the DHC-MD333 to switch the FUNCTION to "TAPE."
- Make sure the AU BUS connecting cord is connected correctly (see page 4).

---

Automatic Source Selection or One Touch Play does not work.

- Make sure the AU BUS connecting cord is connected correctly (see page 4).

---

The functions tied with the DHC-MD333, such as CD Synchro Recording, do not work.

- Make sure the AU BUS connecting cord is connected correctly (see page 4).

---

The inserted tape will not eject.

- | / ⏻ of the tape deck is OFF. Press | / ⏻ to turn on the tape deck, then press ⏹.

---

The cassette indicator flashes.

- Press | / ⏻ to turn off the tape deck, then press | / ⏻ again to turn on the tape deck.
- 

## Specifications

Recording system	4-track 2-channel stereo (DOLBY NR OFF)
Frequency response	50 - 14,000 Hz (±3 dB), using Sony TYPE I cassettes 50 - 15,000 Hz (±3 dB), using Sony TYPE II cassettes
Wow and flutter	±0.13% W. Peak (IEC) 0.07% W. RMS (NAB) ±0.2% W. Peak (DIN)
Input	TAPE IN (phono jacks): impedance 47 kilohms
Output	TAPE OUT (phono jacks): voltage 550 mV impedance 47 kilohms

### General

Power requirements	
North American model:	120 V AC, 60 Hz
European countries model:	220 - 230 V AC, 50/60 Hz 110 - 120 V or 220 - 240 V AC, 50/60 Hz Adjustable with the voltage selector
Other models:	12 W
Power consumption	Approx. 215 × 60 × 230 mm (w/h/d) incl. projecting parts and controls
Dimensions	Mass
	Supplied accessories:
	Audio connecting cords (2)

Design and specifications are subject to change without notice.